

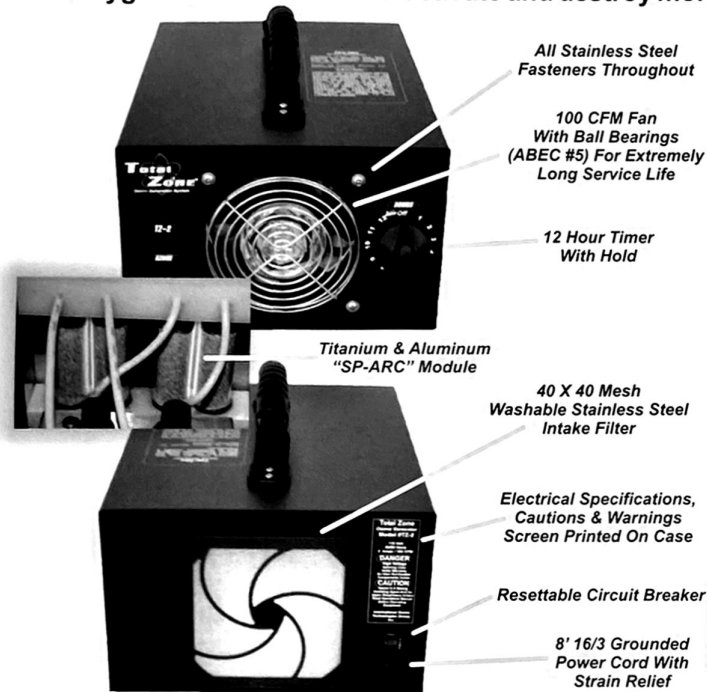

# TZ-1 & TZ-2 Advanced Air Purification Equipment

## What Is Ozone & How Does It Work?

Ozone (O<sub>3</sub>) is a naturally occurring substance found in nature that we cannot live without. Ozone is an activated form of oxygen (O<sub>2</sub>) with three atoms where regular oxygen has two. Ozone in the upper atmosphere filters out harmful rays from the sun without which all life on earth would cease to exist. Closer to home ozone is produced by lightning in thunderstorms. I'm sure you have experienced the freshness in the air after a storm. Ozone is very unstable and has an average half life of 20 minutes, this is why ozone must be produced at the point of use and cannot be stored in a container for later use. Ozone will cast off its third atom onto any other organic element thereby oxidizing it or converting it to another substance. In the case of odors it will convert a foul-smelling substance into a non-odorous substance naturally with no unhealthy chemicals to buy, store or use. Once ozone has done it's job it converts back to oxygen. Ozone will also deactivate and destroy molds, bacteria, virus, fungus, and mildew.



All Stainless Steel Fasteners Throughout

100 CFM Fan With Ball Bearings (ABEC #5) For Extremely Long Service Life

12 Hour Timer With Hold

Titanium & Aluminum "SP-ARC" Module

40 X 40 Mesh Washable Stainless Steel Intake Filter

Electrical Specifications, Cautions & Warnings Screen Printed On Case

Resettable Circuit Breaker

8' 16/3 Grounded Power Cord With Strain Relief

## SPECIFICATIONS

Model	TZ-1	TZ-2
Size	12 1/4" x 9" x 6"	12 1/4" x 9" x 6"
Weight	7 lbs. 9 oz.	9 lbs. 3 oz.
Timer	12 Hour with Hold	12 Hour with Hold
Generator	Patented "SP-ARC" Silicate Polarized Arc Corona Discharge Technology	Patented "SP-ARC" Silicate Polarized Arc Corona Discharge Technology
Fan	100 CFM ABEC #5 Bearings	100 CFM ABEC #5 Bearings
Ozone Output	1500 Milligrams Per Hour	3000 Milligrams Per Hour
Primary Volts / Amps	110 / 1	110 / 2
Secondary Volts / Amps	14000 / .35 ma	2 x 14000 / .35 ma
Cycles	50 / 60	50 / 60
Case Material	Anodized Aluminum .060 / 14 Gauge	Anodized Aluminum .060 / 14 Gauge
Finish	Industrial Powder Coat	Industrial Powder Coat
Warranty	One Year Parts & Labor	One Year Parts & Labor

## Introducing Total Zone

Total Zone ozone generators are the most modern, technically advanced systems on the market today. Total Zone uses a patented corona discharge technology known as "SP-ARC", Silicate Polarized Arc. This new process allows the Total Zone ozone generator to produce much higher levels of ozone than any competitive model with little or no maintenance. All Total Zone ozone generators are designed and built for the utmost reliability in the harshest environments.

## Markets For Total Zone Ozone Generators

- ◆ All hotel rooms can be non-smoking but they can still be smoked in.
- ◆ All used cars can be odor free, easier to sell.
- ◆ All fire and water damage companies use ozone.
- ◆ Apartment complexes can save on carpet replacement and extensive cleaning services after tenants move out, especially if they had animals.
- ◆ Restaurants, Bars, etc. can cut down on offensive odors and give their patrons a much more enjoyable atmosphere to dine and socialize in.
- ◆ Realtors can remove all odors from homes they are trying to sell. A smelly house is hard to sell.
- ◆ Painters can remove the offensive paint odor much sooner so that their customers do not complain.
- ◆ Carpet installers can get rid of the smelly and unhealthy VOCs (Volatile Organic Compounds) put off by new carpet.
- ◆ Rental cars can be deodorized and have smoking odors removed before the next rental.

- ◆ Health clubs and gyms don't have to smell like health clubs and gyms anymore.
- ◆ Dry cleaners use ozone to deodorize draperies and upholstered furniture.
- ◆ Homeowners can have their homes ozoned on a regular basis to keep it fresh, clean smelling and much healthier.
- ◆ Boats can be kept odor, mold, and mildew free.
- ◆ Ozone will kill or deactivate mold, mildew, fungus, bacteria virus, germs, etc.
- ◆ Sick buildings can benefit immensely from regular ozone treatments. This is much cheaper than replacing drywall, carpet, AC duct work, etc.
- ◆ Allergy sufferers can live in a purified environment free from mold, mildew, spores, VOCs, fumes, etc.
- ◆ Businesses can benefit by cutting down on employee sick days by ozoning after hours to rid the work environment of unhealthy substances.
- ◆ Factories can oxidize unlawful and unhealthy chemical emissions from their exhaust systems.



1100 SW 10th. Street, Ste J, Delray Beach, Florida 33444  
(561) 733-8955 Toll Free (877) 40 "OZONE" Fax (561) 733-8953

www.internationalozone.com  
EPA Establishment Registration #87989-FL-001

Manufacturers Of Environmental Products That Solve Problems



# TZ-1 & TZ-2 Advanced Air Purification Equipment

## Natural Odor Removal & Air Purification With Activated Oxygen

*The Total Solution To Air Quality Problems In Your Home Or Business*

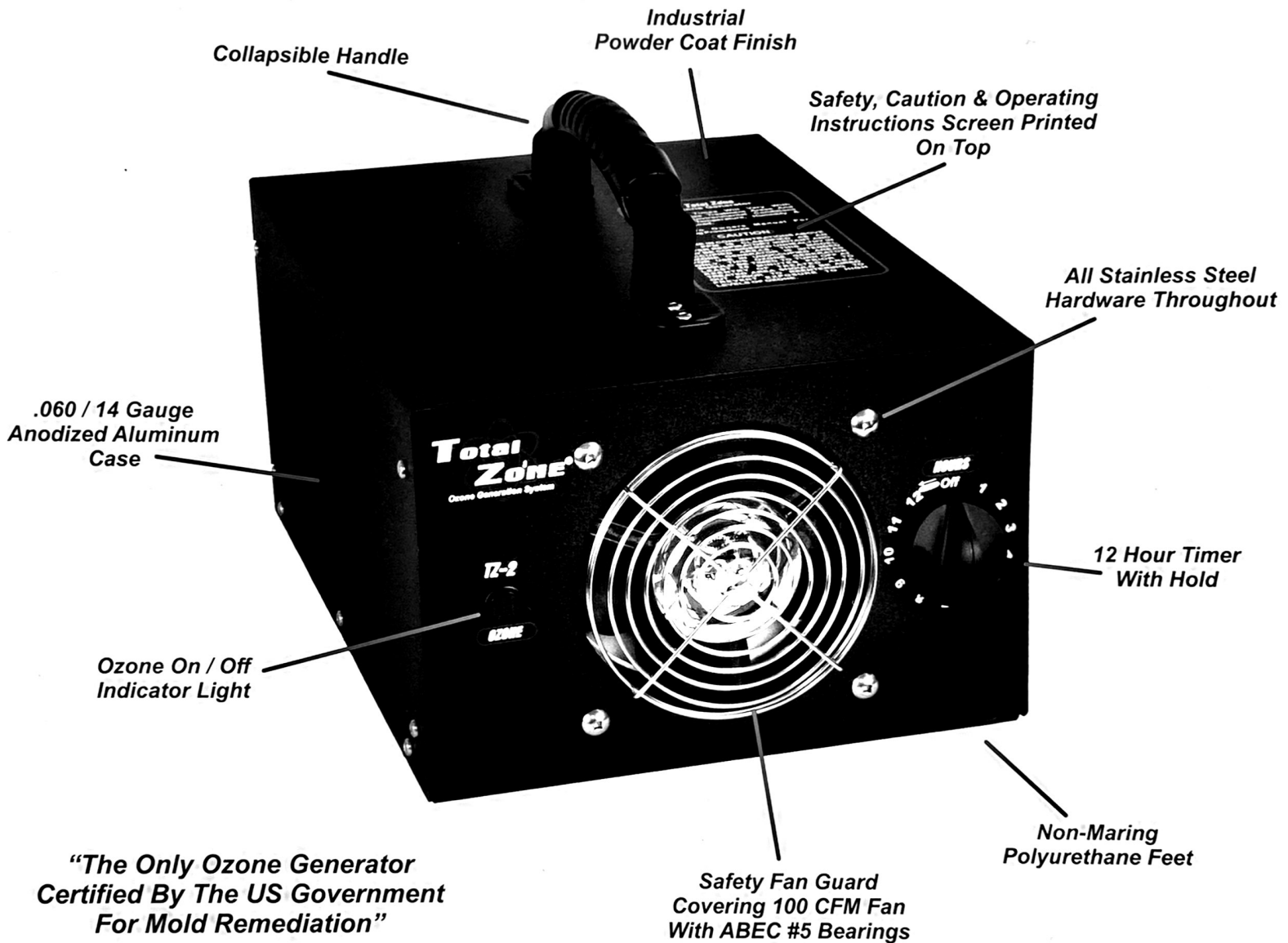

### Total Zone Ozone Generators Will Eliminate:

- ◆ Cigar & Cigarette Odors
- ◆ Pet Odors
- ◆ Mold & Mildew Odors
- ◆ Cooking Odors
- ◆ Offensive Body Odors
- ◆ Germs, Bacteria & Virus
- ◆ Painting Odors
- ◆ New Carpet Odors
- ◆ Smelly Shoe Odors
- ◆ Musty, Stale Odors
- ◆ Beauty Shop Odors
- ◆ Gym Odors
- ◆ Garbage / Dumpster Odors
- ◆ Bathroom Odors
- ◆ Etc... Etc... Etc...

*Manufacturer Of Environmental Products That Solve Problems*

# OWNER'S GUIDE



**Total  
ZONE**  
Ozone Generation System

**TZ-1 / TZ-2  
TZ-4 / TZ-8**

**International Ozone Technologies Group, Inc.**  
Lantana, Florida USA  
2007

*"Manufactures Of Environmental Products That Solve Problems"*

## Copyright

Copyright 2007 International Ozone Technologies Group, Inc. All Rights Reserved. No part of this publication may be reproduced, transmitted, transcribed, stored in a retrieval system, or translated into any language or computer language, in any form or by any means, electronic, mechanical, magnetic, optical, chemical, manual, or otherwise, without the prior written permission of International Ozone Technologies Group, Inc.

Disclaimer: International Ozone Technologies Group, Inc. Shall not be liable for technical or editorial errors or omissions contained herein; nor for incidental or consequential damages resulting from furnishing this material, or the performance or use of this product.

In the interest of continuing product improvement, International Ozone Technologies Group, Inc. reserves the right to change product specifications without notice. Information in this document may change without notice.

### *For Your Records*

The serial number for this product is located on the bottom of the case. Write the model number, serial number and the original date of purchase in the spaces below for future reference for warranty or insurance purposes.

Product Name: ***Total Zone Ozone Generator***  
 Model Number: \_\_\_\_\_  
 Serial Number: \_\_\_\_\_  
 Purchase Date: \_\_\_\_\_

## Glossary

Bacteria	Disease causing microscopic organism.
BOD	Biological Oxygen Demand
CFM	Cubic Feet Per Minute
COD	Chemical Oxygen Demand
Corona	Arcing halo around an electrical discharge.
EPA	Environmental Protection Agency
Fungus	A plant without leaves, flowers or roots. Example = mushroom.
Germ	Disease causing microbe.
Half-life	The time it takes for half the atoms in a substance to decay.
Mildew	A type of destructive fungus that grows in moist environments.
Milligrams Per Hour	Amount of ozone produced, and measured by weight, by a given ozone generator under certain conditions.
Mold	A fungoid growth caused by dampness.
OSHA	Occupational Safety & Health Administration.
Oxidize	To transform a substance by changing its chemical structure. Fire and rust are forms of oxidation.
Ozone	A triatomic form of oxygen with a pungent odor.
PPM	Parts per million. One shot glass in a ten thousand gallon tanker truck is an example of one part per million.
RMA Number	Returned Merchandise Authorization Number
Virus	Disease causing sub-microscopic organisms.
VOC	Volatile organic compound.



WITH BUSINESS RELATIONSHIPS, OR OTHER COMMERCIAL LOSS, EVEN IF ADVISED OF THE POSSIBILITY OF SUCH DAMAGES.

2. ANY OTHER DAMAGES, WHETHER INCIDENTAL, CONSEQUENTIAL OR OTHERWISE.
3. ANY CLAIM AGAINST THE CUSTOMER BY ANY OTHER PARTY.

**Effect of state law:**

This warranty gives you specific legal rights, and you may also have other rights which vary from state to state. Some states do not allow limitations on implied warranties and/or do not allow the exclusion of incidental or consequential damages, so the above limitations and exclusions may not apply to you.

**Sales outside the U.S.A.:**

For **Total Zone** products sold outside of the U.S.A., contact your **Total Zone** dealer for warranty information and service.

# Total Zone<sup>3</sup><sup>®</sup>

Ozone Generation System

## TZ-1 / TZ-2 / TZ-4 / TZ-8 Ozone Generators

### OPERATIONS MANUAL

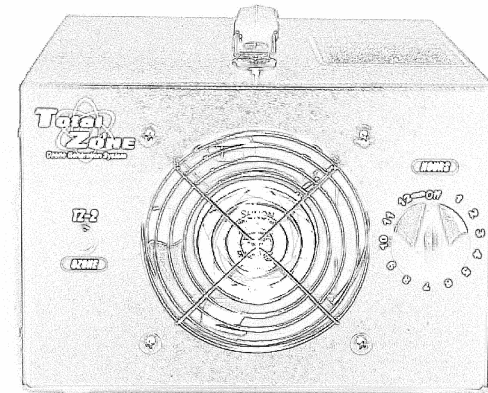

International Ozone Technologies Group, Inc.



Important Safeguards	3
Warnings and Precautions	4
Theory of Operation	5
General Use Guidelines	6
Trouble Shooting	8
Maintenance	9
Specifications	10
Dimensions	11
Front & Back Views Of Your Ozone Generator	12
Money Making Markets	13
A Few Business Opportunities With Ozone	14
Warranty	15
Glossary	17

## LIMITED WARRANTY Total Zone Ozone Generators

**What the warranty covers:**

**International Ozone Technologies Group, Inc.** warrants its products to be free from defects in material and workmanship during the warranty period. If a product proves to be defective in material or workmanship during the warranty period, **International Ozone Technologies Group, Inc.** will, at its sole option, repair or replace the product with a like product. Replacement product or parts may include remanufactured or refurbished parts or components.

**How long the warranty is effective:**

The **Total Zone Ozone Generator** is warranted for one (1) years for all parts and one (1) year for all labor from the date of the first consumer purchase.

**Who the warranty protects:**

This warranty is valid only for the first consumer purchaser.

**What the warranty does not cover:**

1. Any product on which the serial number has been defaced, modified or removed.
2. Damage, deterioration or malfunction resulting from:
  - a. Accident, misuse, neglect, fire, water, lightning, or other acts of nature, unauthorized product modification, or failure to follow instructions supplied with the product.
  - b. Repair or attempted repair by anyone not authorized by **International Ozone Technologies Group, Inc.**
  - c. Any damage of the product due to shipment.
  - d. Removal or installation of the product.
  - e. Causes external to the product, such as electric power fluctuations or failure.
  - f. Use of supplies or parts not meeting **International Ozone Technologies Group, Inc.** specifications.
  - g. Normal wear and tear.
  - h. Any other cause which does not relate to a product defect.
  - i. Shipping & Handling to or from **International Ozone Technologies Group, Inc.**
3. Removal, installation, and set-up service charges.

**How to get service:**

1. For information on obtaining warranty service, call **International Ozone Technologies Group, Inc.** The customer support telephone numbers are: U.S. and Canada 1-877-406-9663. Internet address <http://www.internationalozone.com>
2. To obtain warranty service, you will be required to provide (a) the original dated sales slip, (b) your name, (c) your address, (d) a description of the problem, and (a) the serial number of the product. Obtain a RMA# (Returned Merchandise Authorization) from **International Ozone Technologies Group, Inc.**
3. Take or ship the product prepaid in the original container to **International Ozone Technologies Group, Inc.** at 860-6 N. 8th. St., Lantana, Florida 33462.

**Limitation of implied warranties:**

THERE ARE NO WARRANTIES, EXPRESS OR IMPLIED, WHICH EXTEND BEYOND THE DESCRIPTION CONTAINED HEREIN INCLUDING THE IMPLIED WARRANTY OF MERCHANTABILITY AND FITNESS FOR A PARTICULAR PURPOSE.

**Exclusion of damages:**

**International Ozone Technologies Group, Inc.**'s LIABILITY IS LIMITED TO THE COST OF REPAIR OR REPLACEMENT OF THE PRODUCT. **International Ozone Technologies Group, Inc.** SHALL NOT BE LIABLE FOR:

1. DAMAGE TO OTHER PROPERTY CAUSED BY ANY DEFECTS IN THE PRODUCT, DAMAGES BASED UPON INCONVENIENCE, LOSS OF USE OF THE PRODUCT, LOSS OF TIME, LOSS OF PROFITS, LOSS OF BUSINESS OPPORTUNITY, LOSS OF GOODWILL, INTERFERENCE



## **A Few Business Opportunities With Ozone**

- ▶ Start a service business ozoning used cars at dealerships, apartments for landlords, homes for homeowners, businesses, boats, etc. You can set up a regular route going to auto dealerships once a week to ozone their used cars. You can charge anywhere from \$10.00 to \$50.00 per car depending on the severity of the odor. And who knows how many new used cars they will have per week, One? Five? Ten? How many dealerships are in your town????? How many apartment complexes are in your town????
- ▶ Rent the equipment to business' on a monthly basis with a factory installed timer that will ozone every night after hours so that when the people return to work their air is fresh and purified, free of irritants, germs, bacteria, odors, etc. The customers / patients in restaurants, doctor's offices, etc will be much happier and feel more comfortable coming in to a business that smells good and is germ and irritant free. The business owner can tout the fact that he purifies the air every night, because he cares, by putting a plaque at the front door or waiting area. This will also cut down on employee sick days because the environment they work in will be much healthier. This can be a very profitable long-term income.
- ▶ Rent equipment on short term to painters, homeowners, carpet cleaners and installers, car dealers, rental car companies, motor home rental companies, marinas, etc.



## **Important Safeguards**

- ▶ **Do not operate equipment before reading and familiarizing yourself with all instructions, procedures, cautions and warnings contained in this manual.**
- ▶ **Save these instructions for later reference**
- ▶ **Follow all warnings and cautions marked on the product and contained herein.**
- ▶ **Do not use this product near water or in a moist environment.**
- ▶ **Operate equipment only with the correct electrical power specified on the backside of the case.**
- ▶ **Do not attempt to service this product yourself as opening or removing the enclosure may expose you to dangerous voltage or other hazards.**
- ▶ **Do not put foreign objects inside the equipment.**
- ▶ **Do not operate equipment with a damaged cord or plug, if fans fail to rotate, after the equipment malfunctions or if it has been dropped or damaged in any manner. Return equipment to manufacturer for examination, electrical or mechanical adjustment or repair. (See warranty for information.)**
- ▶ **Do not block air flow through equipment. Set equipment at least 6 inches from walls or any structure that could block the air intake.**
- ▶ **Do not use equipment in a flammable or explosive atmosphere.**



## ***Total Zone Warnings And Precautions***

**OZONE IS A POWERFUL OXIDIZER THAT REACTS WITH ORGANIC SUBSTANCES AND IS CLASSIFIED BY OSHA AND EPA AS AN UPPER RESPIRATORY IRRITANT. OSHA SETS THE ALLOWABLE EXPOSURE LIMITS AT .05 PPM TO .1 PPM. ALL SAFETY PRECAUTIONS HEREIN MUST BE ADHERED TO AND COMMON SENSE PRACTICED.**

The ozone produced by the Total Zone TZ-1, TZ-2, TZ-4 & TZ-8 is above the allowable exposure limit as set by OSHA for inhabited areas and therefor no person or animal should remain in an area being treated by these units. The treated area should be aired out or given enough time for the ozone to dissipate to a level below .1 PPM before people or animals are allowed to re-enter. Ozone has an average half-life of 20 minutes, so one hour should be sufficient time for an un-vented room to return to normal. If ozone odors are noticeable and irritating, the area should be vented longer until the level is reduced. The average person can detect ozone at levels as low as .003 PPM.

Symptoms of prolonged or excessive exposure to ozone are: burning, watery or irritated eyes, nose, and throat, nausea, headache, difficulty in breathing, dry cough, irritation to nasal passages, throat, bronchial and pulmonary membranes.

### **Caution:**

Only qualified personnel should operate Total Zone ozone generators.

As with all electrical devices this equipment should not be operated in a wet or damp environment.

This equipment should only be operated using a properly grounded electrical outlet.

All precautions must be taken to prevent over exposure of ozone gas to occupied areas.

Do not disassemble your Total Zone equipment, there are no user serviceable items inside and this will also void the warranty.

International Ozone Technologies Group, Inc. assumes no liability for damages or injuries incurred by misuse of this equipment.



## **Money Making Markets**

***Odor Control - Ozone is not a cover-up it actually destroys the odor.***

- ▶ All hotel rooms can be non-smoking but they can still be smoked in.
- ▶ All used cars can be odor free, easier to sell.
- ▶ All fire and water damage companies use ozone.
- ▶ Apartment complexes can save on carpet replacement and extensive cleaning services after tenants move out, especially if they had animals.
- ▶ Restaurants, bars, etc. can cut down on offensive odors and give their patrons a much more enjoyable atmosphere to dine and socialize in.
- ▶ Realtors can remove all odors from homes they are trying to sell. A smelly house is hard to sell.
- ▶ Painters can remove the offensive paint odor much sooner so that their customers do not complain.
- ▶ Carpet installers can get rid of the smelly and unhealthy VOCs (Volatile Organic Compounds) put off by new carpet.
- ▶ Rental cars can be deodorized and have smoking odors removed before the next rental.
- ▶ Health clubs and gyms don't have to smell like health clubs and gyms anymore.
- ▶ Dry cleaners use ozone to deodorize draperies and upholstered furniture.
- ▶ Homeowners can ozone on a regular basis to keep their home fresh, clean smelling and free of mold, mildew and germs.
- ▶ Boats can be kept odor, mold, and mildew free.

### ***Air Purification For Healthier Living.***

- ▶ Ozone will kill or deactivate mold, mildew, fungus, bacteria virus, germs, etc.
- ▶ Sick buildings can benefit immensely from regular ozone treatments. This is much cheaper than replacing drywall, carpet, air conditioning duct work, etc.
- ▶ Allergy sufferers can live in a purified environment free from mold, mildew, spores, VOCs, fumes, etc.
- ▶ Businesses can benefit by cutting down on employee sick days by ozoning after hours to rid the work environment of unhealthy substances.
- ▶ Factories can oxidize unlawful and unhealthy chemical emissions from their exhaust systems.







All Stainless Steel Fasteners Throughout

100 CFM Fan With Ball Bearings (ABEC #5) For Extremely Long Service Life

12 Hour Timer With Hold (7 Day Programmable Electronic Optional)

**TZ-1 & 2**

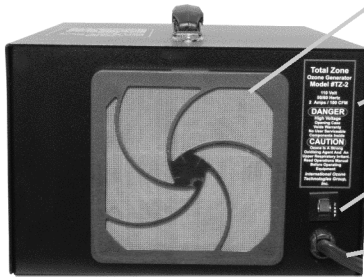

45 Pores Per Inch Washable Stainless Steel Filter

Electrical Specifications, Cautions & Warnings Screen Printed On Case

Resettable Circuit Breaker

8' 16/3 Grounded Power Cord With Strain Relief

Operating Instructions, Cautions & Warnings Screen Printed On Top

Top Mounted On/Off Switches & Indicator Lights (Variable Ozone Output - 25% to 100%)

Top Mounted 12 Hour Timer With Hold (7 Day Programmable Optional)

Recessed Side Mounted Handles

4 - 100 CFM Fans With Sealed ABEC #5 Bearings

.060 / 14 Gauge Anodized Aluminum Case

Stainless Steel Screws, Nuts & Bolts Used Throughout

Fingerprint Free, Durable, Textured Finish

**TZ-4 & 8**

4 - 45 Pores Per Square Inch Washable Stainless Steel Intake Filters

Electrical Specifications, Cautions & Warnings Screen Printed On Case

Rear Mounted Resettable Circuit Breaker

8' 16/3 Grounded Power Cord With Strain Relief

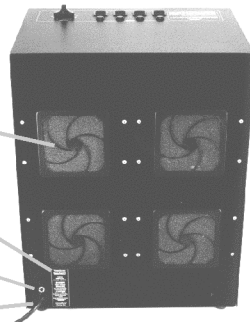

**Theory of Operation**

Your Total Zone ozone generator is the most modern, technically advanced ozone generation system on the market today. The Total Zone utilizes a patent pending "SP-ARC" (Silicate Polarized Arc) technology. This new technology consists of a module comprised of two quartz sleeves containing a proprietary, highly conductive substance surrounding a stainless steel electrode. The two sleeves are mounted so as to facilitate a gap between of 3/32". One electrode is connected to ground while the other is charged with high voltage at a very low current. This charge creates an arc in the air gap between the two sleeves which is known as "Corona Discharge". When oxygen, O<sub>2</sub>, passes through this arc some of the molecules are split resulting in free oxygen atoms. These free atoms combine back with intact O<sub>2</sub> molecules resulting in O<sub>3</sub> which is ozone. The main benefits of our new technology are that it is self-cooling and runs at a low temperature. Also, all ozone-producing surfaces are comprised of silicate quartz with no metal components that will corrode and need cleaning on a regular basis as in most other corona discharge ozone generators. Our systems are very high output with no to very low maintenance.



## General Use Guidelines

Determine the source of the odor and remove any odor causing substance that can be found. If the odor is from a wet or flooded situation dry the entire area well before starting your ozonation procedure.

Determine the size of the area that will be ozonated. Multiply the width by the length by the height to determine the total cubic feet of the area.

The following suggestions are general. The actual time it will take to remove an odor or to purify an area depends on many variables such as pollutant load, temperature, humidity, etc.

Divide the fan output (TZ-1 & TZ-2 = 100 cfm, TZ-4 & TZ-8 = 400 cfm) into the total cubic feet to be ozonated. Example: 10' wide x 10' long x 10' high room = 1000 cubic feet. Divide 100 cfm (TZ-1) into 1000 = 10. It will take ten minutes for a TZ-1 to completely fill that area with ozone. Our general rule of thumb is. Whatever the final figure you come up with once you divide the fan cfm, from the unit you are using, into the total cubic feet of the area you are ozoning you would double that time for a TZ-1, use that exact time for a TZ-2. Use the exact time for a TZ-4, and cut the time in half if you are using a TZ-8.

Examples for 1000 cubic feet.

TZ-1 (100 cfm times 2) = 20 Minutes

TZ-2 (100 cfm) = 10 Minutes

TZ-4 (400 cfm) = 2.5 Minutes

TZ-8 (400 cfm divided by 2) = 1.25 Minutes

As stated above, these are just general guidelines. In some cases you will have to go longer and in other cases you will go shorter. Once you have become experienced with using ozone for odor removal you will be able to determine the treatment times from your past experiences. As you can tell by the examples above the TZ-4 & TZ-8 are strong units designed for large areas but they are adjustable for variable, 100, 200, 300 and 400 cfm, output so you can use them in small areas.

Set your ozone generator by the air conditioner return if possible. If there is no air conditioning set the unit in the middle of the area. You may want to use additional fans to help distribute the ozone. If there is AC set the

## Dimensions

### TZ-1 & 2

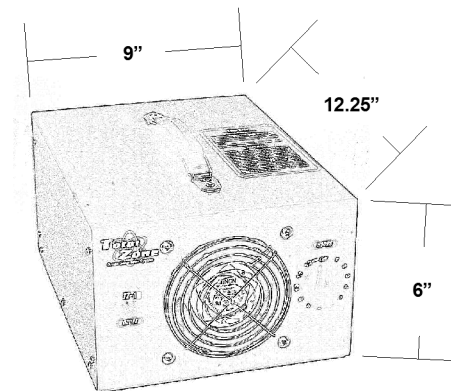

### TZ-4 & 8

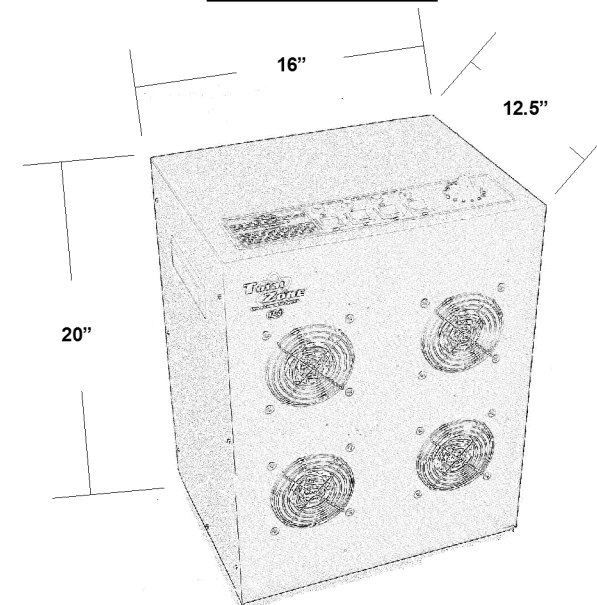

	<b>TZ-1</b>	<b>TZ-2</b>	<b>TZ-4</b>	<b>TZ-8</b>
<b>Model</b>				
<b>Size</b>	12 1/4" x 9" x 6"	12 1/4" x 9" x 6"	12 1/2" x 16" x 20"	12 1/2" x 16" x 20"
<b>Weight</b>	7 lbs. 9 oz.	9 lbs. 3 oz.	26 lbs. 5 oz.	33 lbs. 6 oz.
<b>Timer</b>	12 Hour with Hold	12 Hour with Hold	12 Hour with Hold	12 Hour with Hold
<b>Generator</b>	Patented Silicate Polarized Arc Technology	Patented Silicate Polarized Arc Technology	Patented Silicate Polarized Arc Technology	Patented Silicate Polarized Arc Technology
<b>Fan</b>	100 CFM ABEC #5 Bearings	100 CFM ABEC #5 Bearings	4 - 100 CFM ABEC #5 Bearings	4 - 100 CFM ABEC #5 Bearings
<b>Ozone Output</b>	1500 Milligrams Per Hour	3000 Milligrams Per Hour	1500 to 6000 Milligrams Per Hour- Variable	3000 to 12000 Milligrams Per Hour- Variable
<b>Primary Volts / Amps</b>	110 / 1	110 / 2	110 / 3	110 / 4
<b>Secondary Volts / Amps</b>	14000 / .35 ma	2 x 14000 / .35 ma	4 x 14000 / .35 ma	8 x 14000 / .35 ma
<b>Cycles</b>	50 / 60	50 / 60	50 / 60	50 / 60
<b>Case Material</b>	Anodized Aluminum .060 / 14 Gauge	Anodized Aluminum .060 / 14 Gauge	Anodized Aluminum .060 / 14 Gauge	Anodized Aluminum .060 / 14 Gauge
<b>Finish</b>	Industrial Powder Coat	Industrial Powder Coat	Industrial Powder Coat	Industrial Powder Coat
<b>Warranty</b>	One Year Parts & Labor	One Year Parts & Labor	One Year Parts & Labor	One Year Parts & Labor



thermostat on constant fan and adjust the temperature control to a low (cold) setting. Ozone generators work best in a cool, low humidity environment. The secondary benefit of running the AC is that you will purify the inside of the ductwork where mold and mildew love to grow. After the treatment, when the AC is turned on, the air will be clean and fresh with no germs, pollutants or irritants blended into it. The above also should be followed when ozoning automobiles. Smoke and stale odors will stay in a car's AC ducts if you do not run the AC.

Close all exterior doors and windows. Set the ozone generator's timer for the time you have determined that will be needed. Make note of this time, as you do not want to return to the treated area until at least 20 minutes after the equipment has shut off. If you must enter the area before the ozone has had time to convert back to oxygen open all windows and doors to vent the ozone. DO NOT breathe high levels of ozone. International Ozone Technologies Group, Inc. offers a small digital ozone monitor that can be used to tell if the ozone levels are too high. Be safe and use common sense at all times when you are using ozone.



<i>Problem</i>	<i>Possible Cause</i>	<i>Remedy</i>
Unit does not turn on.	Power cord not plugged in.	Plug power cord into suitable outlet with correct voltage.
	Circuit breaker in building tripped.	Reset circuit breaker at panel box.
	Faulty power outlet.	Try another outlet.
Unit keeps blowing fuses.	Fuse is blown on back of unit.	Replace fuse with correct replacement.
	Too small amperage fuse being used.	Replace fuse with correct fuse as specified on the back panel of unit.
Unit does not produce ozone.	Electrical short circuit.	Return unit to manufacturer for repair.
	Damage or malfunction in "SP-ARC" module or transformer.	Return unit to manufacturer for repair.

**Maintenance**

Your Total Zone ozone generator was engineered, designed and built to require very little maintenance. The only maintenance necessary to keep your Total Zone running at peak performance is to rinse the stainless steel intake filter(s) located on the back of the unit with soap and water, air dry, then re-install. If you ever feel that your Total Zone is not producing ozone at the level it did when it was new, call the factory for a RMA number and ship the unit back. We will inspect and diagnose the problem. If the equipment only needs adjustments or cleaning to bring it back into specifications we will gladly service and re-certify your equipment **free of charge**, you only pay shipping and handling.

